

NYC MODEL

COMPANY NAME _____

APPROVED BY (PLEASE PRINT) _____

APPROVAL SIGNATURE _____

DATE _____ CONTRACT NO. _____

TANK TO BE INSTALLED AS PER
NYC BUILDING CODE ARTICLE 17-
FUEL OIL EQUIPMENT, C26-1416.

NOTES :

1. SHELL: 1/4" , HEAD: 5/16"
CONTAINMENT: 1/4"
2. CONTAINMENT CAPACITY =
150% TANK CAPACITY
3. MATERIAL - MILD CARBON STEEL.
4. TEST - 30 PSIG (HYDRO).
5. ENTIRE UNIT UL LISTED, NOT JUST
PRIMARY TANK.
6. PAINT - RED PRIMER (STANDARD).
7. FOR FURTHER INFORMATION CALL
1-800-242-2736 OR FAX (516) 366-0905.

ITEM #	DESCRIPTION
①	1" FILL BOX OVERFLOW PIPE
②	PUMP PLATFORM W/2" LIP
③	1/2" DRAIN FITTING W/ PLUG
④	2" VENT FITTING
⑤	6" - 8 oz FLNGD EMERGENCY VENT SHIPPED LOOSE:
⑥	VENT DEFLECTOR ASSEMBLY SHIPPED LOOSE
⑦	3" FCPLGS
⑧	3" FITTING
⑨	OVERFILL CONTAINMENT CHAMBER
⑩	STAIRS, PLATFORM AND HANDRAIL- DESIGNED TO OSHA REQUIREMENTS SHIPPED LOOSE
⑪	3/4" PUMPOUT PIPE W/ 3" PIPE CAP SUMP
⑫	1" PIPE UNION
⑬	4" FITTING
⑭	(2) 3" FITTING

SECTION A-A

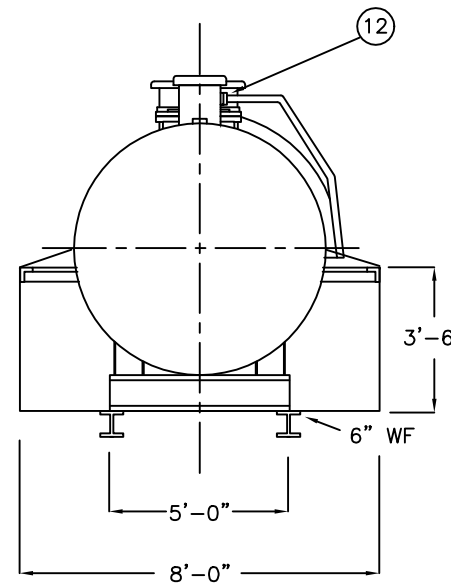

All rights reserved. This drawing or any part thereof must not be reproduced in any form without the written permission of Areo-Power Unitized Fueler, Inc.

AREO-POWER®

TITLE 3000 GAL. NYC FUELER		REV #	REV DATE
U.S. PATENT # 4895272	CANADIAN PATENT APPLIED FOR		
SCALE NONE	DATE 3/27/91	DRAWN BY JF	DWG. NO. UL3K64NY